

TDS21 WIFI THERMOSTAT



I. Product Summary:

Beok WiFi touch screen thermostat can be controlled by phone. It is applied to temperature control of industrial, commercial and domestic room, and start of control heating appliances, especially floor heating systems. It can be controlled by phone. Phone systems are IOS and Android system optional.

II. Technical Parameter:

| | |
|------------------------------|---|
| Working voltage | 200~240V _{ac} |
| Current load | 16A for electrical floor heating 3A for water floor heating |
| Temperature control accuracy | 0.5 degree |
| Setting temperature range | 5~60℃ |
| Limiting temperature range | 5~99℃ |
| Consumption | <0.15W |
| Temperature sensor | NTC |

III. Main Button Instruction

- ON/OFF Switch;
- Mode Button: Switch between manual mode and program mode
Long press to enter period setting.
- Time set: Hour, minute and week setting.
- Up button: To increase temperature.
- Down button: To reduce temperature.

IV. User Interface Explanation

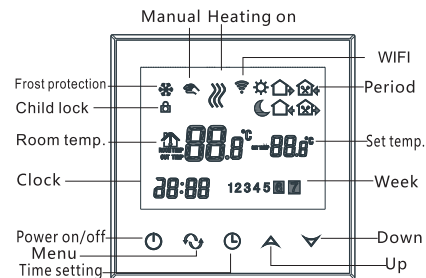

V. User Interface Explanation (Phone Port)

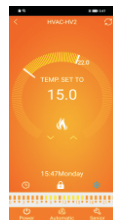

VI. Model Spec

| Model | Current Loading | External Sensor | Week Program | Controlled Objects |
|----------|-----------------|-----------------|--------------|---------------------------------|
| WIFI-EP | 16A | ✓ | ✓ | For electric heating appliances |
| WIFI-WP | 3A | | ✓ | For water heating appliances |
| WIFI-WPB | 3A | | ✓ | for gas boiler |

VII. Wiring Diagram

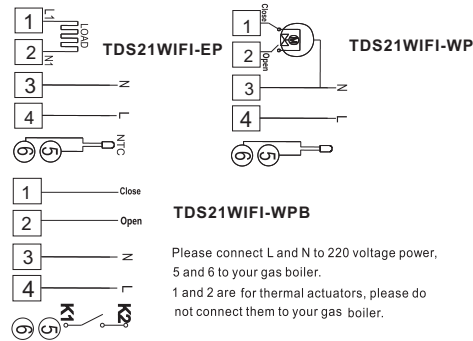

Remarks: please read wiring diagram carefully before connecting. If you connect it wrongly, there will be a short circuit. Your gas boiler board will be damaged!!!

VIII. Thermostat Operation Instruction

- Setting Power on/off**
Press to turn on/off the power.
- Setting Temperature**
Press to set the temperature.
- Setting the Clock**
Press to set minute, hour and week.
Press for adjusting.
- Setting the Manual Mode.**
Manual mode means non-programmable mode.
Press then will display in the screen, it is in manual mode.
Press to set the temperature.
Press to set minute, hour and week.
- Setting the Child Lock**
Long press to enter into child lock mode, will display.
Long press again, the child lock will be disappeared.
- Setting the Programmable Mode.**
Press and hold into programmable mode. LOOP and 12345 will display.
Press to select the control way: 5+2 or 6+1 or 7 days programmable.
12345 display in the position of week means 5+2;
123456 display in the position of week means 6+1;
1234567 display in the position of week means 7 days programmable.
Press to select the periods.
Press to change the temperature;
Press to do time adjustment.
Press to change the time;
Press again to select the weekend's time.
If you want to make temporary adjustment in any period, press then will flash. When finish the setting, all will confirm automatically.

Press to switch operation between manual mode and programmable mode.

| Period | Period Icon | Defaulted Time | Defaulted Temp. |
|---------|-------------|----------------|-----------------|
| Week | 1 | | 6:00 20℃ |
| | 2 | | 8:00 15℃ |
| | 3 | | 11:30 15℃ |
| | 4 | | 12:30 15℃ |
| | 5 | | 17:30 22℃ |
| | 6 | | 22:00 15℃ |
| Weekend | 1 | | 8:00 22℃ |
| | 2 | | 23:00 15℃ |

Remark:
(1) The defaulted temperature of period3 and period4 is the same as period2. Please change it according to the request.

7. Advanced Setting

In the state of power-off, long press and hold then press into advanced setting mode. Then press to set relative item.

| Display Code | Function | Setting And Options | Factory Default |
|--------------|--------------------------------------|--|------------------------|
| SEN | Sensor mode | 0:Internal sensor 1:Floor sensor 2:Both internal sensor and floor sensor | 0 |
| OSV | Set temp. range for floor sensor | 5-99℃ | 42℃ |
| DIF | Precision for floor temp. | 1-9℃ | 2℃ |
| SVH | High limit temp. for internal sensor | 5-99℃ | 35℃ |
| SVL | Low limit temp. for internal sensor | 5-99℃ | 5℃ |
| ADJ | Measure temp. | Check and calibrate the actual room temp. | 0.5℃accuracy calibrate |
| FRE | Frost-protection | 00 : Off 01 : On | 00 |
| PON | Power memory | 00 : Off 01 : On | 00 |
| DFI | Precision for room temp. | 0.5-3℃ | 1℃ |
| Opt | Linkage terminal output direction | 00:Set temp>Room temp, relay close 01:Set temp<Room temp, relay close | 00: Positive output |
| FAC | Factory setting | 06 : Just display 00 : Factory reset | 08 |

For Opt:
When the thermostat connect with gas boiler, the terminal short circuit is extinguished, the open circuit is ignition. Then Turn to the reverse output '01'.
When the Opt is adjusted to 00, thermostat can also be used in the water floor heating system, the water temperature is too low will prohibit the output (relay output 3A/200W), this function only suits for wifi linkage function thermostat.

DFI:
Explanation:
For example, if Room temp is 22℃, Hysteresis'DFI'=1, when room temp rise to 23℃, the relay will stop outputting; when room temp down to 21℃, the relay will output again and start heating.
DFI is hysteresis for room temp, factory set is 1, if 1 is too big for you, it can be adjusted to 0.5.

IX. Phone Port Operation Instruction

- Install APP on phone**
For iOS system: Login in App Store, search " Beok Home", you can download it on your iphone.
Or scan below code to download:



For Android System: Login in Google Play, search "Beok Home", you can download it on your phone.
Or scan below code to download:



2. Connection Thermostat with Phone

Thermostat Setting

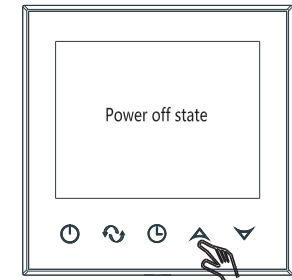

Press up Hold on for 10 seconds

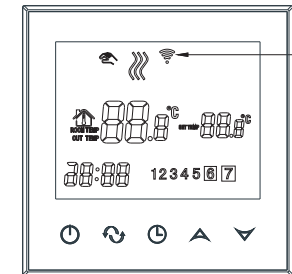

During the configuration process the WIFI icon flashes briefly to start the configuration network Valid for 2 minutes

At this time, wifi symbol will be twinkling quickly and frequently. It means, you can connect thermostat with phone now. When wifi symbol stop twinkling, it means thermostat is successfully connected with phone.

Connection with Phone

Open " Beok Home " APP on your phone, you can see APP welcome page.

Enter your wifi name and password, then start connection at below. When connection success, it will appear "Connection Success".



After connection success, you need press "Search" key.

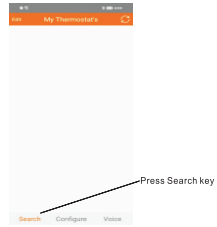

Then it will appear your wifi thermostat HVAC. HVAC is the factory setting name, when you have more than 2 thermostats, you can change it to any name you want.

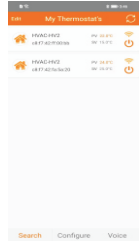

- Long press HVAC for 5 seconds, it will appear Edit Thermostat page.
- Press Modify Current Thermostat.
- You can change HVAC to room 1, Bedroom Bath room, or anything you like.

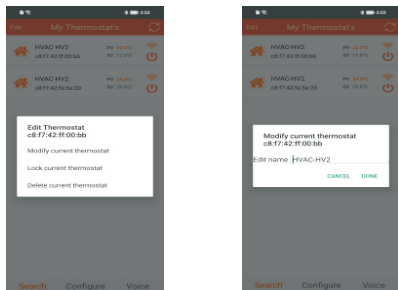

APP Interface on the Phone

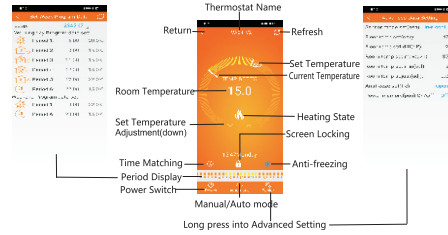

Thermostat Setting through Phone Operation

- Clock**: You can press Time Matching switch to match your phone clock with thermostat clock.
- Children lock (screen locking)**: Press to lock the thermostat.
- Anti-Freezing**: Press thermostat will show on the screen, it means Anti-freezing function open.
- Temperature setting**: You can directly drag the pointer on Temperature Setting Dial to set temperature. Or press and to set temperature step.
- Period setting**: Long press Period Display then you will go into the Period Setting mode:

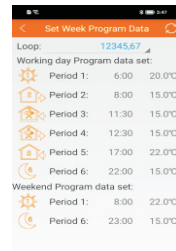

Touch work loop: you can choose the week program mode: 5+2/ 6+1 /7. Touch each time value: you can set the time of the period. Touch each temperature: you can set the temperature of the period. Notice: When you choose the program mode to 7, Weekend program data set will no appear.

- Advanced Setting**: Long Press Senior , you will go into Advanced setting mode:

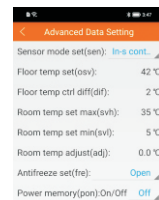

| Display Code | Function | Setting And Options | Factory Default |
|--------------|-----------------------|--|-----------------|
| SEN | Sensor mode | In-s control Out-s control In-s control, Out-s limit | In-s control |
| OSV | Floor set temp. range | 5-99°C | 42°C |
| DIF | Floor temp. ctrl diff | 1-9°C | 2°C |
| SVH | Room temp set max | 5-99°C | 35°C |
| SVL | Room temp set min | 5-99°C | 5°C |
| ADJ | Room temp. adjust | -5-5°C | 0°C |
| FRE | Anti-frozen | close/open | Close |
| PON | Power memory | off/on | On |

- Switch of Manual mode and Auto mode: Press to switch manual mode or Auto mode.
- Power off: Press to turn on or off thermostat,



X. Attention to Phone WiFi Connection:

- After you press Configure, if connection fails:
 - Please confirm your mobile phone is set to WLAN mode, and ensure its (mobile data)/3g/4g is turned off. Please connect to 2.4G wifi, not 5G wifi.
 - Please add your wifi router name, we recommend it does not include spaces or Chinese symbol.
 - Please check your wifi router password. We recommend not over 32 characters, no spaces, no blank password, no special symbols except letters and numbers.
 - AP config: AP thermostat hotspot configuration (operate FAC=12 in advanced settings).
 - Please confirm wifi password is correctly filled. We recommend you check password to be visible when it is input.
- If it displays the following reminder, please go to Advanced Setting to reset corresponding setting.

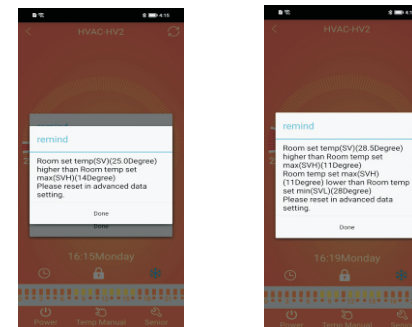

XI. Installation Instruction

This product is suitable for standard 80*80mm wall box and 60 mm european round box.

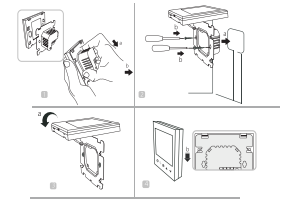

- Open the main control board as shown in the figure, press the power part of the thermostat, gently lift it up, and separate it from the mounting board hook.
- Connect the wires correctly according to the wiring diagram and secure the rear cover to the mounting plate with M4 screws
- Connect the lower cover cable to the upper cover.
- Insert the back into the four hooks of the mounting plate. Gently press down on the thermostat to lock the front housing and complete installation

NOTICE: The installation wire should be 1.5-2.5mm².

XII. ATT:

Thank you for buying this product!

Please read this manual for complete instructions on installing and operating your thermostat. If you require further assistance, please feel free to contact us.

In the box you will find:

| | Model | TDS21WIFI-EP | TDS21WIFI-WP | TDS21WIFI-WPB |
|-----------------|-------|--------------|--------------|---------------|
| Thermostat | | ✓ | ✓ | ✓ |
| User Manual | | ✓ | ✓ | ✓ |
| Screws | | ✓ | ✓ | ✓ |
| External sensor | | ✓ | | |

Our Service:

We offer the warranty of 24 months from the sales day.

During the warranty, if it is belong to the quality issue, we will fix or replace them for you by free after test them.

If it is not quality problem or beyond the warranty time, we will charge for the after-sales service.

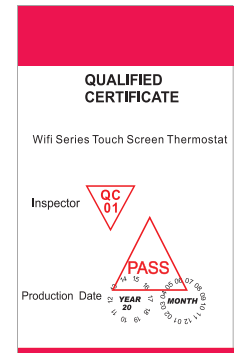

Warning:



The symbol means the unit is being installed, it may cause electrical shock hazard during maintaining, so please make sure it is operated by the professional technical worker.

